

PNP Silicon AF Transistor Array

- For AF input stages and driver applications
- High current gain
- Low collector-emitter saturation voltage
- Two (galvanic) internal isolated Transistors with good matching in one package

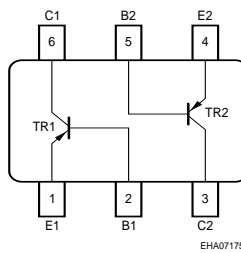
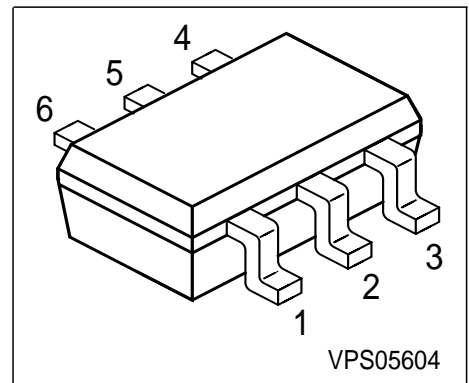

Type	Marking	Pin Configuration				Package		
BC857S	3Cs	1=E1	2=B1	3=C2	4=E2	5=B2	6=C1	SOT363

Maximum Ratings

Parameter	Symbol	Value	Unit
Collector-emitter voltage	V_{CEO}	45	V
Collector-base voltage	V_{CBO}	50	
Collector-emitter voltage	V_{CES}	50	
Emitter-base voltage	V_{EBO}	5	
DC collector current	I_C	100	mA
Peak collector current	I_{CM}	200	
Total power dissipation, $T_S = 115\text{ °C}$	P_{tot}	250	mW
Junction temperature	T_j	150	°C
Storage temperature	T_{stg}	-65 ... 150	

Thermal Resistance

Junction - soldering point ¹⁾	R_{thJS}	≤140	K/W
--	------------	------	-----

¹⁾For calculation of R_{thJA} please refer to Application Note Thermal Resistance

Electrical Characteristics at $T_A=25^\circ\text{C}$, unless otherwise specified

Parameter	Symbol	Values			Unit
		min.	typ.	max.	
DC Characteristics per Transistor					
Collector-emitter breakdown voltage $I_C = 10\text{ mA}, I_B = 0$	$V_{(BR)CEO}$	45	-	-	V
Collector-base breakdown voltage $I_C = 10\text{ }\mu\text{A}, I_E = 0$	$V_{(BR)CBO}$	50	-	-	
Collector-emitter breakdown voltage $I_C = 10\text{ }\mu\text{A}, V_{BE} = 0$	$V_{(BR)CES}$	50	-	-	
Emitter-base breakdown voltage $I_E = 10\text{ }\mu\text{A}, I_C = 0$	$V_{(BR)EBO}$	5	-	-	
Collector cutoff current $V_{CB} = 30\text{ V}, I_E = 0$	I_{CBO}	-	-	15	nA
Collector cutoff current $V_{CB} = 30\text{ V}, I_E = 0, T_A = 150\text{ }^\circ\text{C}$	I_{CBO}	-	-	5	μA
DC current gain 1) $I_C = 10\text{ }\mu\text{A}, V_{CE} = 5\text{ V}$ $I_C = 2\text{ mA}, V_{CE} = 5\text{ V}$	h_{FE}	- 200	250 290	- 630	-
Collector-emitter saturation voltage1) $I_C = 10\text{ mA}, I_B = 0.5\text{ mA}$ $I_C = 100\text{ mA}, I_B = 5\text{ mA}$	V_{CEsat}	- -	75 250	300 650	mV
Base-emitter saturation voltage 1) $I_C = 10\text{ mA}, I_B = 0.5\text{ mA}$ $I_C = 100\text{ mA}, I_B = 5\text{ mA}$	V_{BEsat}	- -	700 850	- -	
Base-emitter voltage 1) $I_C = 2\text{ mA}, V_{CE} = 5\text{ V}$ $I_C = 10\text{ mA}, V_{CE} = 5\text{ V}$	$V_{BE(ON)}$	600 -	650 -	750 820	V

 1) Pulse test: $t < 300\mu\text{s}$; $D < 2\%$

Electrical Characteristics at $T_A = 25\text{ }^\circ\text{C}$, unless otherwise specified.

Parameter	Symbol	Values			Unit
		min.	typ.	max.	
AC characteristics					
Transition frequency $I_C = 20\text{ mA}$, $V_{CE} = 5\text{ V}$, $f = 100\text{ MHz}$	f_T	-	250	-	MHz
Collector-base capacitance $V_{CB} = 10\text{ V}$, $f = 1\text{ MHz}$	C_{cb}	-	3	-	pF
Emitter-base capacitance $V_{EB} = 0.5\text{ V}$, $f = 1\text{ MHz}$	C_{eb}	-	10	-	
Short-circuit input impedance $I_C = 2\text{ mA}$, $V_{CE} = 5\text{ V}$, $f = 1\text{ kHz}$	h_{11e}	-	4.5	-	k Ω
Open-circuit reverse voltage transf.ratio $I_C = 2\text{ mA}$, $V_{CE} = 5\text{ V}$, $f = 1\text{ kHz}$	h_{12e}	-	2	-	10^{-4}
Short-circuit forward current transf.ratio $I_C = 2\text{ mA}$, $V_{CE} = 5\text{ V}$, $f = 1\text{ kHz}$	h_{21e}	-	330	-	-
Open-circuit output admittance $I_C = 2\text{ mA}$, $V_{CE} = 5\text{ V}$, $f = 1\text{ kHz}$	h_{22e}	-	30	-	μS
Noise figure $I_C = 200\text{ }\mu\text{A}$, $V_{CE} = 5\text{ V}$, $R_S = 2\text{ k}\Omega$, $f = 1\text{ kHz}$, $\Delta f = 200\text{ Hz}$	F	-	-	10	dB

Total power dissipation $P_{tot} = f(T_S)$

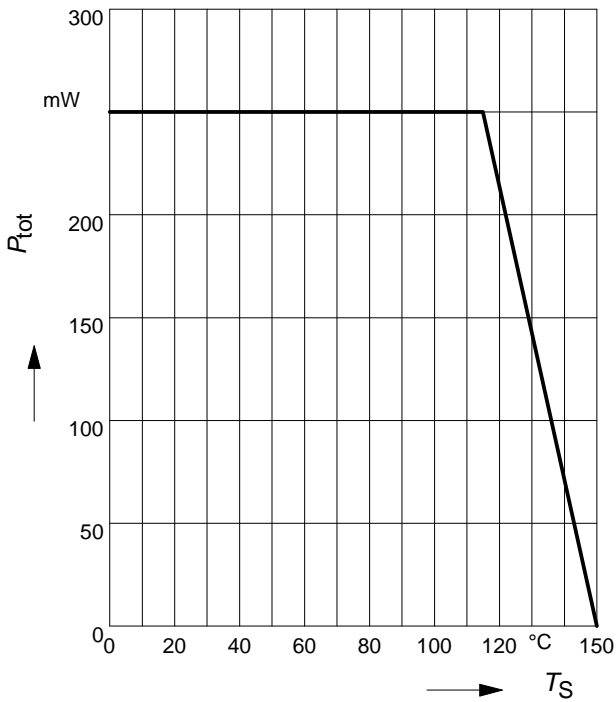

Permissible Pulse Load $R_{thJS} = f(t_p)$

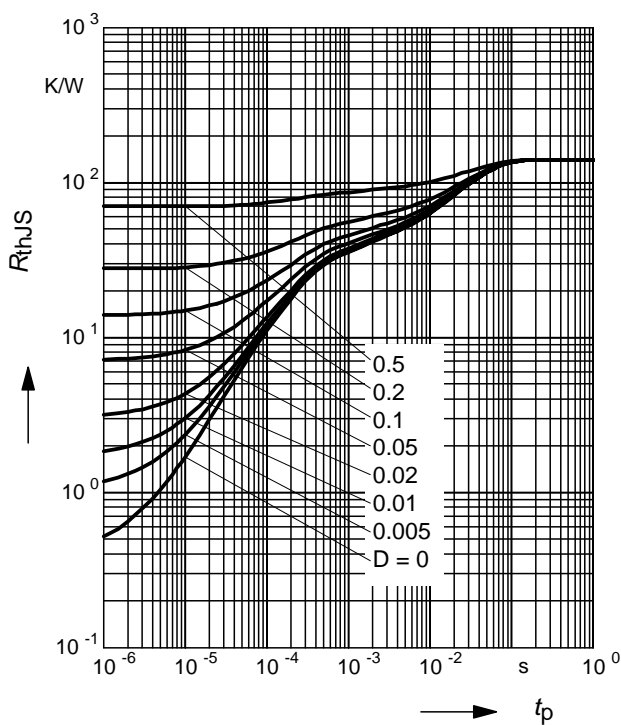

Permissible Pulse Load

$P_{totmax} / P_{totDC} = f(t_p)$

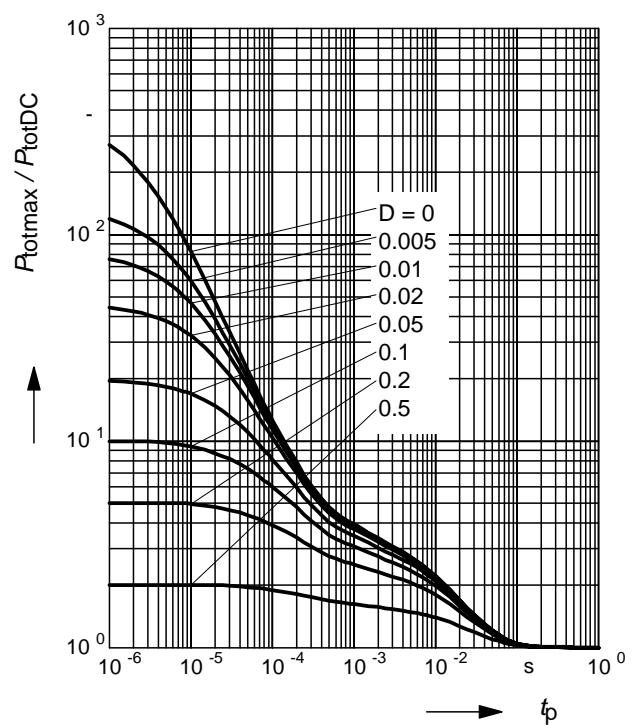

Transition frequency $f_T = f(I_C)$

$V_{CE} = 5V$

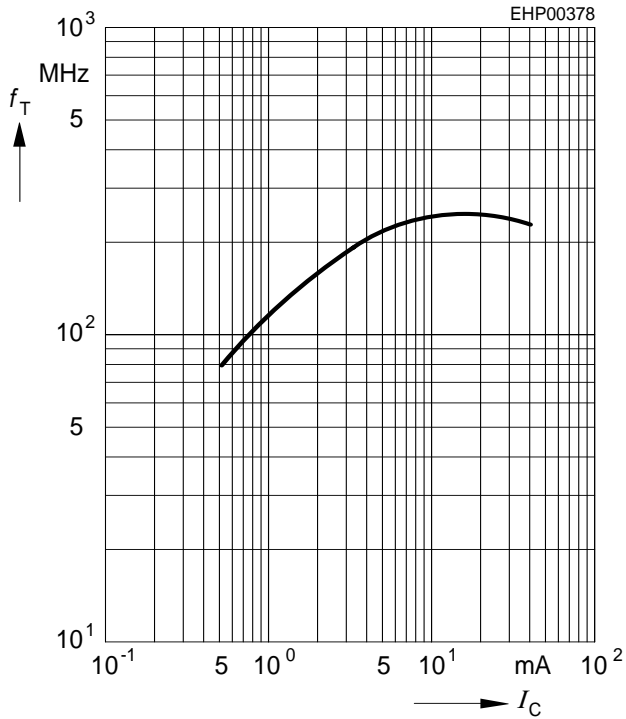

Collector-base capacitance $C_{CB} = f(V_{CB0})$

Emitter-base capacitance $C_{EB} = f(V_{EB0})$

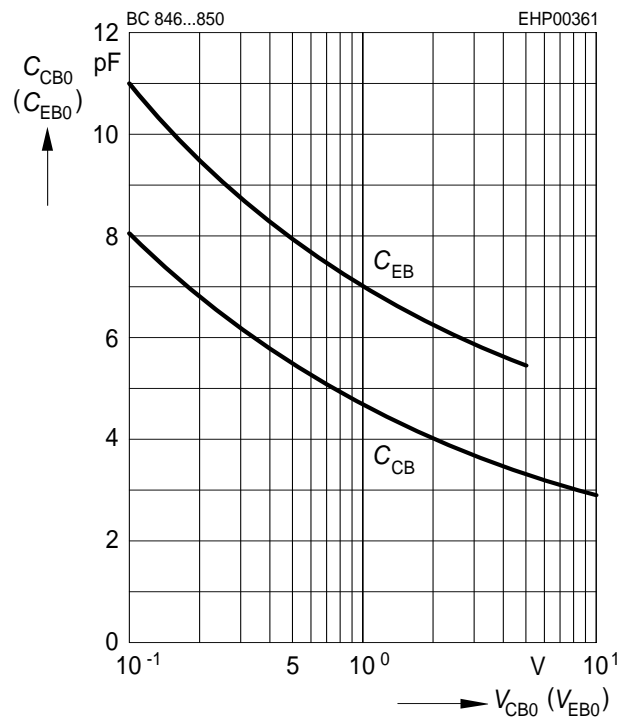

Collector cutoff current $I_{CBO} = f(T_A)$

$V_{CB} = 30V$

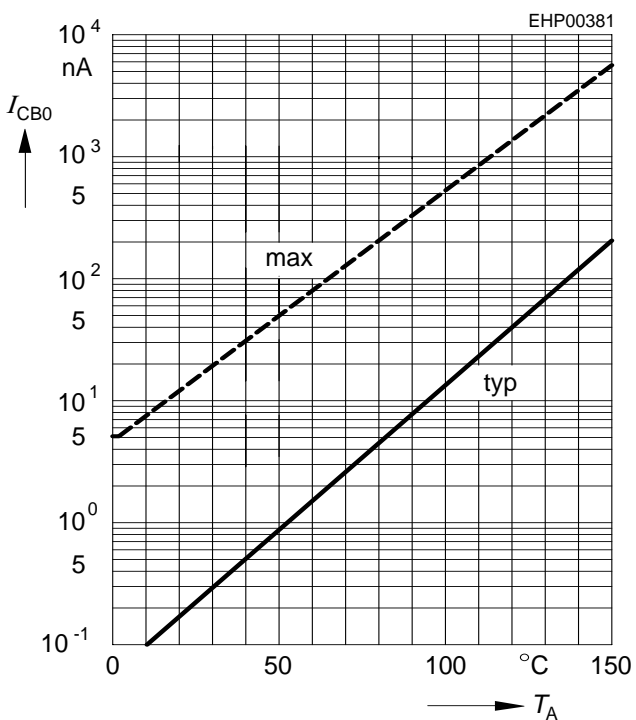

Collector-emitter saturation voltage

$I_C = f(V_{CEsat}), h_{FE} = 20$

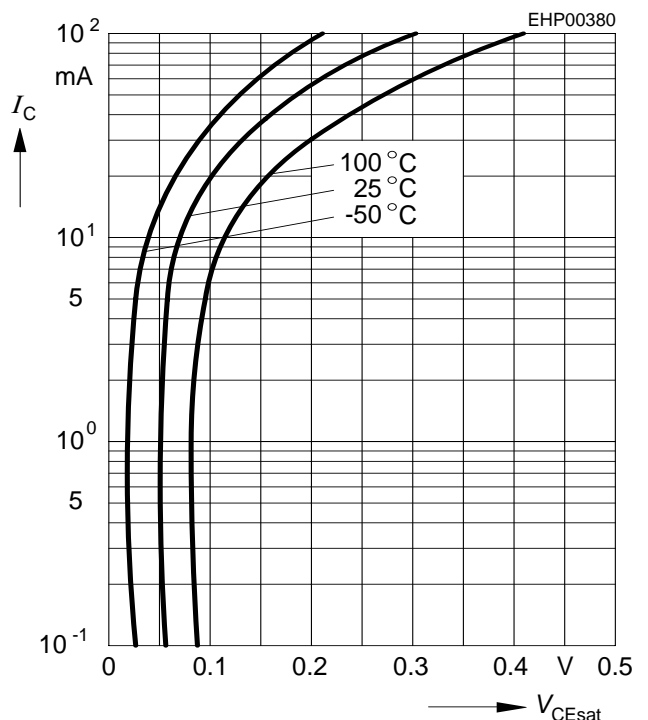

DC current gain $h_{FE} = f(I_C)$

$V_{CE} = 5V$

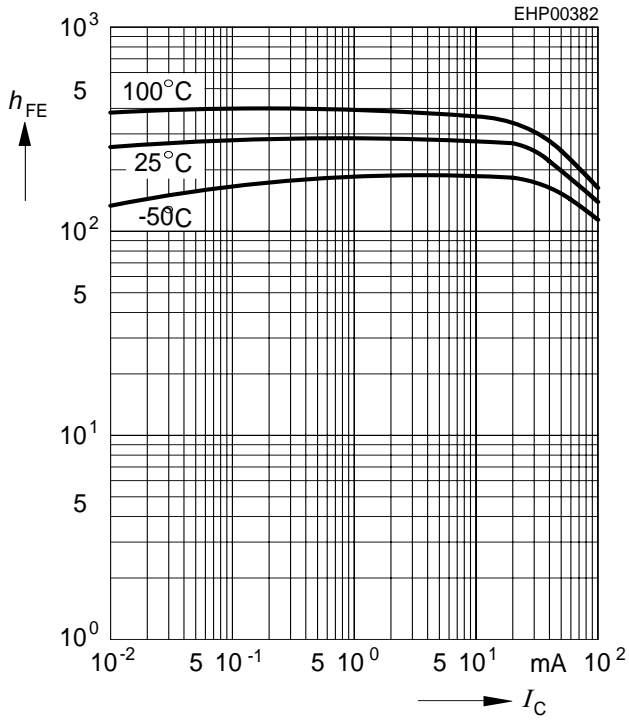

Base-emitter saturation voltage

$I_C = f(V_{BEsat}), h_{FE} = 20$

